

# **DATI TECNICI - TECHNICAL DATA**

## **DONNÉES TECHNIQUES - DATOS TÉCNICOS**

DIMENSIONI - DIMENSIONS - DIMENSIONS - DIMENSIONES (mm)

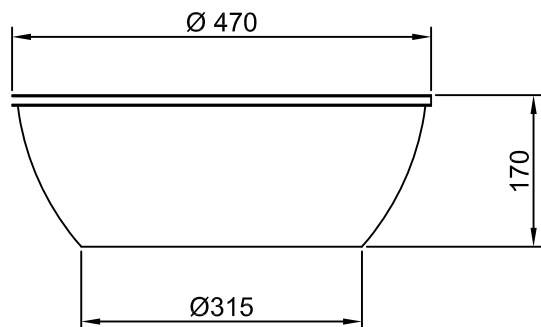

Ta : - 20°C + 40°C

# GRUPPO RAINA

IDEALLUX SRL

Sede Legale / Registered Office: Corso Novara, 121 - 27029 Vigevano (PV)

Sede Operativa / Headquarters: Via Casinghino, 11 - 27024 Cilavegna (PV)

Tel. +39 0381 969814 Fax +39 0381 669709

www.grupporaina.it - grupporaina@ideallux.it - ideallux@pec.it

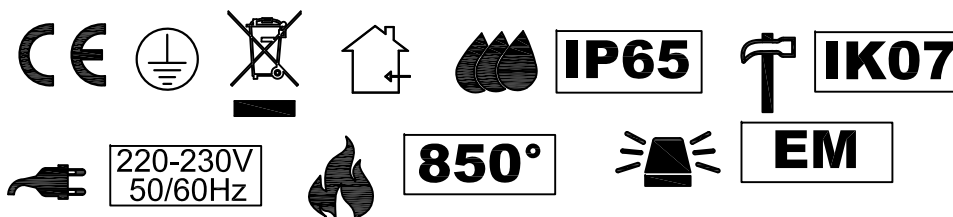

- La sorgente luminosa contenuta in questo apparecchio deve essere sostituita solo dal costruttore o dal suo servizio di assistenza o da personale altrettanto qualificato.

ATTENZIONE: qualsiasi tentativo di intervento sui LED, non autorizzato dal fabbricante, comporta la decadenza immediata della garanzia. Pertanto, in caso di disservizio dell'apparecchio occorre fare una segnalazione al fabbricante per la riparazione o sostituzione.

**IMPORTANTE - LA GARANZIA NON VIENE RICONOSCIUTA NEI SEGUENTI CASI :**

Errata installazione - Errato collegamento alla linea di alimentazione - Negligente stoccaggio e brandeggio - Sostituzione di componenti con altri non di nostra fornitura - Manomissione - Assenza o non corretta manutenzione - Mancato rispetto delle istruzioni di montaggio allegate - Installazione in aree sismiche o comunque con presenza di forti vibrazioni - Danni causati da atti di vandalismo - Mancanza etichette dati e N° certificato di collaudo.

- The light source contained in this appliance must only be replaced by the manufacturer or his service agent or similarly qualified personnel.

PLEASE NOTE: any attempt to intervene on the LEDs not authorised by the manufacturer shall immediately void the warranty. Therefore, in case of malfunction, contact the manufacturer for repairing or replacing the product.

**PLEASE NOTE - THE WARRANTY DOES NOT APPLY IN THE FOLLOWING CASES:**

Incorrect installation - Incorrect connection to the power supply line - Negligent storage and handling - Replacement of components with other components not supplied by us - Tampering - Lack of or incorrect maintenance - Failure to comply with the annexed assembly instructions - Installation in seismic areas or areas subject to strong vibrations - Damages caused by vandalism - Lack of data labels and test certificate number.

- La source lumineuse contenue dans cet appareil ne doit être remplacé par le fabricant ou son agent de service ou similaire personnel qualifié.

VEUILLEZ NOTER: toute tentative d'intervention sur les LED non autorisées par le fabricant annule immédiatement la garantie. Par conséquent, en cas de dysfonctionnement, contactez le fabricant pour réparer ou remplacer le produit.

**IMPORTANT - LA GARANTIE N'EST PAS RECONNUE DANS LES CAS SUIVANTS :**

Installation incorrecte - Connexion incorrecte à la ligne d'alimentation - Stockage et inclinaison négligents - Remplacement de composants par d'autres non fournis par nous - Altération - Absence ou maintenance incorrecte - Non-respect des instructions de montage jointes - Installation dans des zones sismiques ou dans tous les cas avec la présence de fortes vibrations - Dommages causés par des actes de vandalisme - Absence d'étiquettes de données et de certificat de test n°

- La fuente de luz contenida en este aparato solo debe reemplazado por el fabricante o su agente de servicio o similar personal calificado.

ATENCIÓN: cualquier intento de intervención en los LED, no autorizado por el fabricante, invalidará inmediatamente la garantía. Por lo tanto, en caso de mal funcionamiento del aparato, se debe informar al fabricante para su reparación o sustitución.

**IMPORTANT - LA GARANTÍA NO SE RECONOCE EN LOS SIGUIENTES CASOS:**

Instalación incorrecta - Conexión incorrecta a la línea de alimentación - Almacenamiento y vuelco negligente - Sustitución de componentes por otros no suministrados por nosotros - Manipulaciones - Ausencia o mantenimiento incorrecto - Incumplimiento de las instrucciones de montaje adjuntas - Instalación en zonas sísmicas o en cualquier caso con presencia de fuertes vibraciones - Daños causados por actos de vandalismo - Falta de etiquetas de datos y certificado de prueba No.



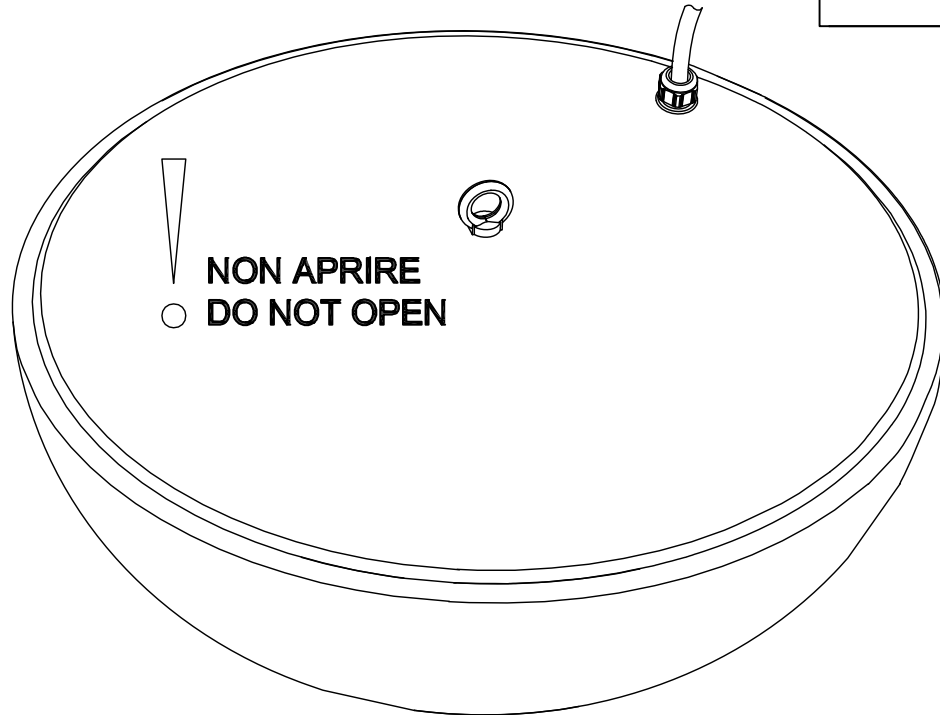
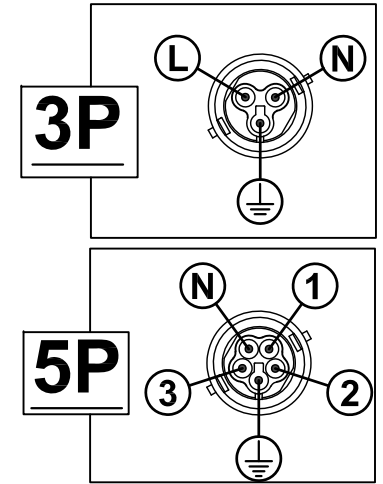
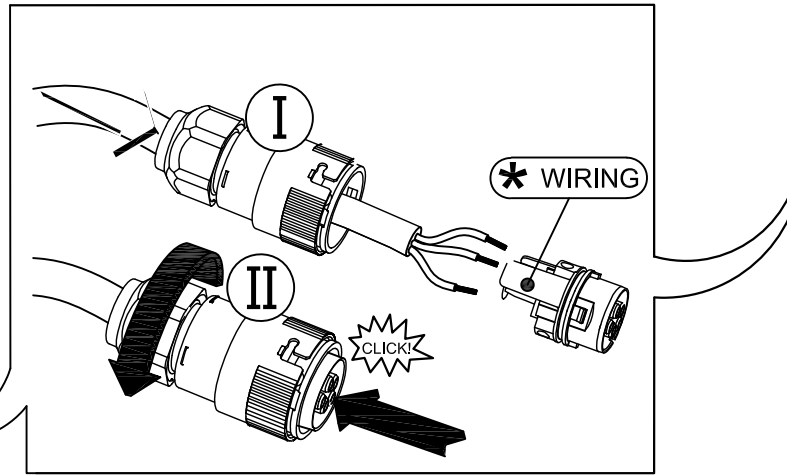
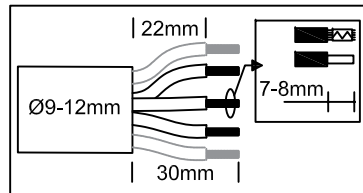
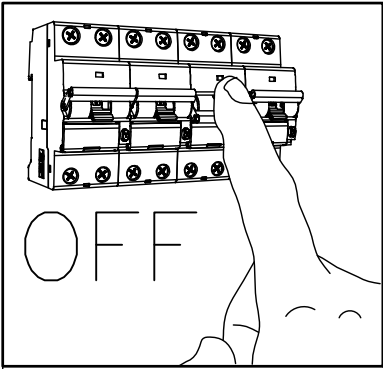

**\* WIRING**

**DALI 5P**  
LUIxxxDLxx

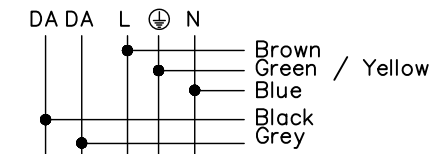

- A = Brown = Fase - Phase line
- B = Blue = Neutro linea - Neutral line
- C = Yellow/Green = Messa a terra - Earthing
- D = Black = Dali
- E = Grey = Dali

**ON/OFF 3P**  
LUIxxxx

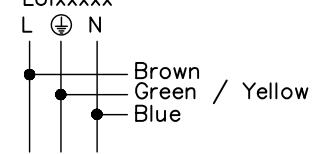

- A = Brown = Fase - Phase line
- B = Blue = Neutro linea - Neutral line
- C = Yellow/Green = Messa a terra - Earthing

- A = Marrone - Brown - Marron - Marròn
- B = Blu - Blue - Bleu - Azul
- C = Giallo/Verde - Yellow/Green - Jaune/Vert - Amarillo/Verde
- D = Nero - Black - Noir - Negro
- E = Grigio - Grey - Gris - Gris

