

BINARIO DALI STANDARD • STANDARD TRACK DALI

Binario elettrico icato realizzato in profilo di alluminio a sezione quadrata.
Electrified track manufactured in square profile extruded aluminium.
Rail électrifié réalisé en profil d'aluminium à section carrée.
Carril electrificado realizado de perfil de aluminio de sección cuadrada.

Lunghezza Lenght	Codice Code	Colore Colour
BINARIO STANDARD DALI • STANDARD TRACK DALI		
1000	HR7511/10	<ul style="list-style-type: none"> ● 31: Bianco white RAL9016 ● 30: Nero black RAL 9005 ● 42: Anodizzato anodized
2000	HR7511/20	
3000	HR7511/30	





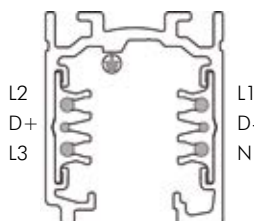
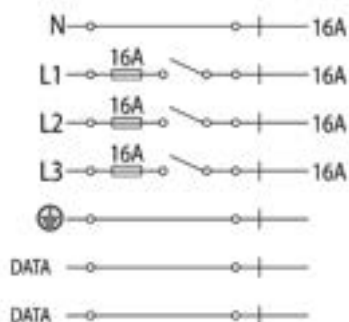



















POSIZIONAMENTO DELL'ALIMENTAZIONE DEI CONDUTTORI DI TERRA. POSITION OF THE SUPPLY OF EARTH CONDUCTORS.



SCHEMA ELETTRICO TRIFASE A TENSIONE DI RETE 230/250V.
 THREE-PHASE ELECTRIC DIAGRAM FOR MAINS VOLTAGE 230/250V.

ACCESSORI PER BINARIO STANDARD DALI.

ACCESSORIES FOR STANDARD TRACK DALI.

accessori accessories		codice code	accessori accessories		codice code
	Adattatore meccanico 6A - carico meccanico 5 Kg. <i>Mechanical electrical adapter 6A - mechanical load 5 Kg.</i>	7601-00		Giunto flessibile. <i>Flexible joint.</i>	7658-10
	Adattatore meccanico. <i>Mechanical electrical adapter.</i>	7625-00		Giunto lineare con contatti. <i>Electrical straight joint.</i>	7604-10
	Alimentazione destra. <i>Right power supply.</i>	7652-10		Giunto lineare senza contatti. <i>Mechanical joint.</i>	7654-10
	Alimentazione sinistra. <i>Left power supply.</i>	7652-11		Chiusura. <i>End cap.</i>	7659-00
	Alimentazione centrale e giunto lineare. <i>Central connector and straight joint.</i>	7653-10		Copertura binario 1000 mm. <i>Track cover 1000 mm.</i>	7624-00
	Giunto L interno. <i>Interior L joint.</i>	7655-10		Kit attacco soffitto. <i>Ceiling kit.</i>	7607-00
	Giunto L esterno. <i>Exterior L joint.</i>	7655-11		Sospensione kit cavo acciaio 2000 mm (piattina 60). <i>Suspension kit with steel wire 2000 mm (plate 60).</i>	7606-00
	Giunto T sinistro esterno. <i>Left outside T joint.</i>	7656-10		Sospensione kit cavo acciaio 2000 mm (piattina 120). <i>Suspension kit with steel wire 2000 mm (plate 120).</i>	7606-05
	Giunto T destro esterno. <i>Right outside T joint.</i>	7656-12		Piattina 120 mm. <i>Plate 120 mm.</i>	7606-04
	Giunto T destro interno. <i>Right inside T joint.</i>	7656-13		Piattina 60 mm. <i>Plate 60 mm.</i>	7606-02
	Giunto T sinistro interno. <i>Left inside T joint.</i>	7656-11		Adattatore con trasformatore elettr. 50W con jack femmina. <i>Adapter with transformer 50W with female jack.</i>	7601-11
	Giunto X. <i>X joint.</i>	7657-10			

FOCUS PRODOTTO | PRODUCT FOCUS

