

WALLEY XP 1

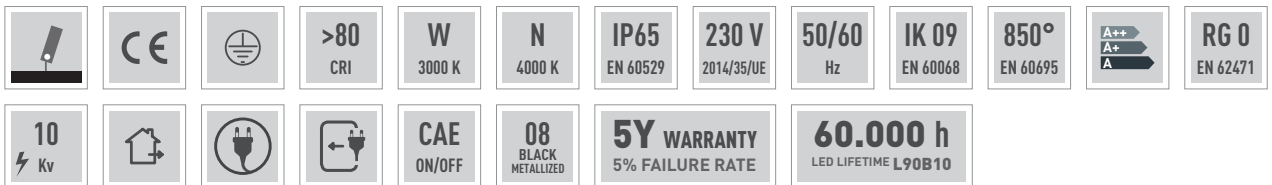

EN

Extruded anodized aluminum body with heat-sink function. Bent steel adjustable bracket and frame painted with epoxy powders after phosphating complete with goniometer. Direct light emission. Street optics in high performance optical molded silicone with high mechanical resistance, anti-yellowing and anti-scratch. LED light source. IP66 quick plug-in connector for power line included. High frequency (CAE) ballast in separate IP65 box fixed to the body.

ES

Cuerpo en aluminio extruido anodizado con función de disipador. Marco y soporte regulable de acero plegado a presión barnizado con polvo epoxi previamente fosfatado, completo de goniómetro. Emisión directa. Óptica vial en silicona estampada de alto rendimiento con alta resistencia mecánica, anti-amarilleo y anti-rayado. Fuente de luz LED. Conector rápido IP66 para alimentación incluido. Alimentación electrónica CAE externa, IP65 fijada al cuerpo.

IT

Corpo in alluminio estruso anodizzato con funzione di dissipatore. Telaio e staffa regolabile in acciaio pressopiegato verniciati con polveri epossidiche previa fosfatazione, completa di goniometro. Ottiche stradali in silicone stampato ad alto rendimento ottico con elevata resistenza meccanica, anti-ingiallimento ed antigraffio. Emissione diretta. Sorgente luminosa LED. Connettore rapido IP66 per linea di alimentazione incluso. Alimentazione elettronica CAE esterna, IP65 fissata al corpo.

DE

Körper aus eloxiertem extrudiertem Aluminium mit Kühlkörperfunktion. Rahmen und verstellbare Halterung aus gepresstem Stahl, der nach der Phosphatierung mit Epoxidpulver lackiert wurde, komplett mit Goniometer. Straßenoptik aus optisch geformtem Hochleistungssilikon mit hoher mechanischer Beständigkeit, Vergilbungs- und Kratzfestigkeit. Direkte Lichtemission. LED-Lichtquelle. Direkte Ausgabe. IP66-Schnellverbinder für Stromleitung enthalten. Externe elektronische Stromversorgung, IP65 am Gehäuse befestigt.

FR

Corps en aluminium extrudé et anodisé avec fonction de dissipateur. Support de fixation réglable, pliée à la presse, en acier traité avec peinture epoxy pulvérisé par phosphatation. Émission directe. Optiques routières encapsulées dans le silicone moulé offrant une haute transparence optique, résistance mécanique élevée, et un fort indice de réfraction. Forte résistance aux UVs, aux chocs et aux rayures. Source lumineuse LED. Connecteur rapide IP66 pour ligne électrique incluse. Alimentation électronique CAE externe IP65 fixée au corps.

RU

Анодированный экструдированный алюминиевый корпус с функцией радиатора. Регулируемая рама и кронштейн из гнутой фосфатированной стали, окрашенные эпоксидными красками-порошками, в комплекте с транспортом. Уличная оптика из высокоэффективного оптического литого силикона с высокой механической прочностью, устойчивого к пожелтению и царапинам. Прямой поток света. Светодиодный источник света. Быстроразъемное соединение IP66 для линии электроподключения включено в комплект. Внешний электронный блок питания CAE, IP65 закреплен на корпусе.

WALLEY XP 1 AS



Code	Lm LED	Lm Out	Watt Out	Lm Watt Out	Relamping
KWYX16016ASW/N08	13840	9960	95	> 104	150
KWYX18018ASW/N08	15450	10770	105	> 103	150

w/N= **W** (3000 K) | **N** (4000 K)

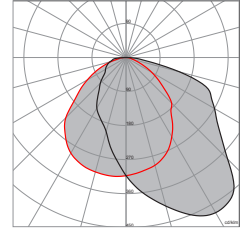

Lm Led/Lm Out:
Standard - **N** (4000 K)
-8% - **W** (3000 K)

WALLEY XP 1 AS2



Code	Lm LED	Lm Out	Watt Out	Lm Watt Out	Relamping
KWYX16016AS2W/N08	13840	9575	95	> 100	150
KWYX18018AS2W/N08	15450	10560	105	> 101	150

w/N= **W** (3000 K) | **N** (4000 K)

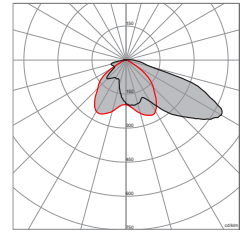

Lm Led/Lm Out:
Standard - **N** (4000 K)
-8% - **W** (3000 K)

WALLEY XP 1 D



Code	Lm LED	Lm Out	Watt Out	Lm Watt Out	Relamping
KWYX16016DW/N08	13840	10340	95	> 108	150
KWYX18018DW/N08	15450	11400	105	> 109	150

w/N= **W** (3000 K) | **N** (4000 K)

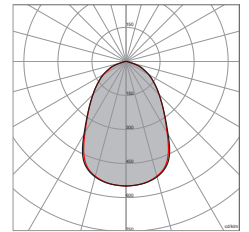

Lm Led/Lm Out:
Standard - **N** (4000 K)
-8% - **W** (3000 K)

WALLEY XP 1 C



Code	Lm LED	Lm Out	Watt Out	Lm Watt Out	Relamping
KWYX16016CW/N08	13840	10080	95	> 112	150
KWYX18018CW/N08	15450	11120	105	> 106	150

w/N= **W** (3000 K) | **N** (4000 K)

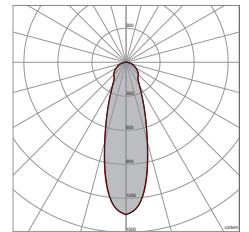

Lm Led/Lm Out:
Standard - **N** (4000 K)
-8% - **W** (3000 K)



Code

Code Ordering example: **KWYX16016 AS W/N 08**

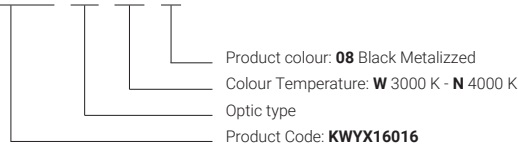

WALLEY XP

DIMENSIONAL + FIXTING

WALLEY XP 1

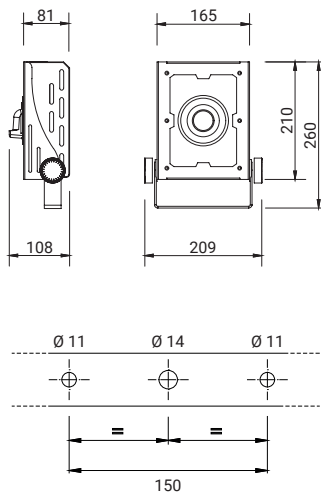

WIND RESISTANCE

WALLEY XP 1

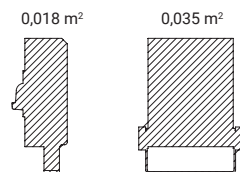

WEIGHT (Kg)

4,5

MINIMUM AND MAXIMUM ENVIRONMENT TEMPERATURE (Ta)

-20 ~ +45°C